

## MAINTENANCE

Scheduled Maintenance	Normal Usage		Severe Usage*	
	Inspect/Replace	Mileage	Inspect/Replace	Mileage
Air Cleaner Filter	Inspect/Replace	7,500/30,000	Inspect/Replace	Same As Normal/More Frequently
Engine Oil and Filter	Replace	7,500 or 12 mos.	Replace	3,750 or 6 mos.
Power Steering Fluid	Inspect	7,500	Inspect	Same As Normal
Tire Rotation	Perform	7,500	Perform	7,500
Vacuum Hose	Inspect	7,500	Inspect	Same As Normal
Climate Control Air Filter (For Evaporator and Blower Unit)	Replace	10,000	Replace	More Frequently
Air Conditioning Refrigerant	Inspect	15,000	Inspect	Same As Normal
Brake Hoses & Lines	Inspect	15,000	Inspect	Same As Normal
Drive Shafts & Boots	Inspect	15,000	Inspect	7,500
Electronic Throttle Control	Inspect	15,000	Inspect	Same As Normal
Exhaust Pipe & Muffler	Inspect	15,000	Inspect	Same As Normal
Front Disc Brake/Pads, Calipers & Rotors	Inspect	15,000	Inspect	More Frequently
Fuel Tank Air Filter	Inspect	15,000	Inspect	Same As Normal
Power Steering Pump, Belt & Hoses	Inspect	15,000	Inspect	Same As Normal
Propeller Shaft (AWD)	Inspect	15,000	Inspect	7,500
Steering Gear Box, Linkage & Boots/ Lower Arm Ball Joint, Upper Arm Ball Joint	Inspect	15,000	Inspect	More Frequently
Suspension Mounting Bolts	Inspect	15,000	Inspect	Same As Normal
Brake Fluid	Inspect	30,000	Inspect	Same As Normal
Parking Brake	Inspect	30,000	Inspect	More Frequently
Fuel Lines, Fuel Hoses and Connections	Inspect	30,000	Inspect	Same As Normal
Rear Brake Disc/Pads	Inspect	15,000	Inspect	More Frequently
Vapor Hose, Fuel Tank & Fuel Filler Cap	Inspect	30,000	Inspect	Same As Normal
Fuel Filter	Inspect	37,500	Replace	More Frequently
Rear Axle Oil (AWD)	Inspect	40,000 or 48 mos.	Replace	80,000
Transfer Case Oil (AWD)	Inspect	40,000 or 48 mos.	Replace	80,000
Valve Clearance	Inspect	60,000	Inspect	Same As Normal
Spark Plugs (Iridium Coated)	Replace	100,000 or 10 yrs.	Replace	More Frequently
Drive Belts	1st Replace 60,000 or 72 mos. Add'l Replace 15,000 or 24 mos.		Inspect	Same As Normal
Coolant	1st Replace 120,000 or 120 mos. Add'l Replace 30,000 or 24 mos.		Replace	Same As Normal
Automatic Transaxle Fluid	No check, No service required		Replace	60,000

\*See Owner's Manual for details.

**Looking for more detailed information?** This Quick Reference Guide does not replace your vehicle's Owner's Manual. If you require additional information or are unsure of a specific issue, you should always refer to the vehicle's Owner's Manual or contact your authorized Hyundai dealer.

The information contained in this Quick Reference Guide was correct at the time of printing; however, specifications and equipment can change without notice. No warranty or guarantee is being extended in this Quick Reference Guide, and Hyundai reserves the right to change product specifications and equipment at any time without incurring obligations. Some vehicles are shown with optional equipment. Specifications apply to U.S. vehicles only. Please contact your Hyundai dealer for current vehicle specifications.

NP150-J2011  
(Rev 12/10/10)  
Printing XX/XX/XX

# HYUNDAI VERACRUZ

## Quick Reference Guide



[www.hyundai.com](http://www.hyundai.com)

Roadside Assistance: **1-800-243-7766**  
Consumer Affairs: **1-800-633-5151**  
XM® Radio: **1-800-967-2346**

# Table of contents

Audio	20
AUX, USB and iPod port	21
AWD lock	27
Central door lock switch	08
Child-protector rear door lock	10
Climate control	16-19
Clock adjustment	22
Cruise control system	25
Electronic Stability Control (ESC)	27
Front seat adjustment (Manual/Power)	02
Fuel filler lid	11
Head lights and fog lights	12
Headrest adjustment	03
Hood release	10
Inside rearview mirror	06
Instrument cluster	14
Instrument panel illumination	15
Interior lights	24
Occupant Classification System	05
Outside rearview mirror	07
Power window	11
Proximity key	09
Rear seat folding	03
Remote keyless entry	08
Seat belt adjustment	05
Seat warmer	22
Steering wheel audio control	21
Sunroof	23
Tilt and telescopic steering wheel	04
Tire Pressure Monitoring System (TPMS)	25
Transmission	26
Trip computer	15
Wiper and washer	13

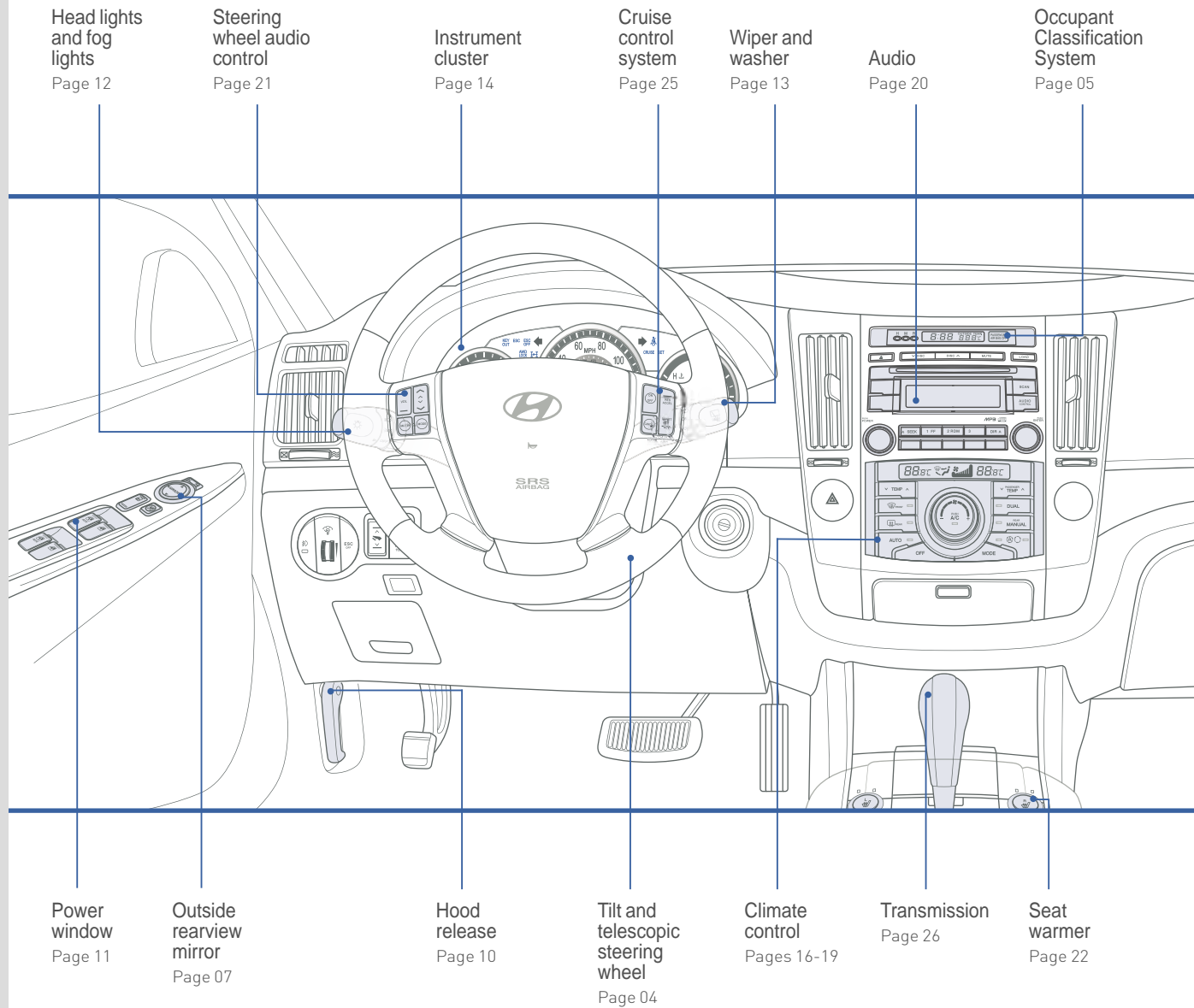

## FRONT SEAT ADJUSTMENT (Manual) (if equipped)

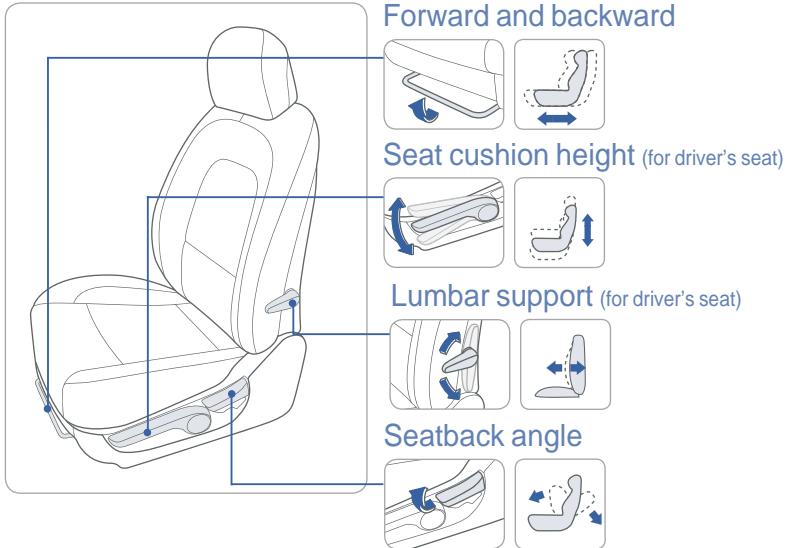

## HEADREST ADJUSTMENT

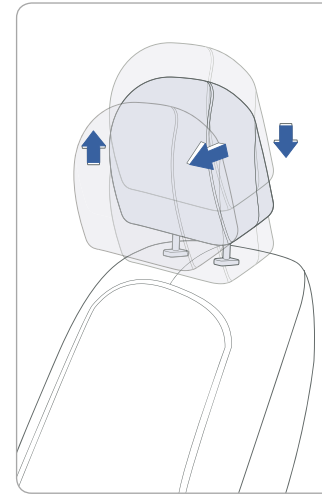

### Height adjustment

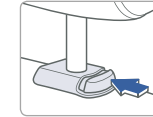

Lock knob  
Pull up to raise.  
Press lock knob to lower.

### Backward adjustment

To adjust the headrest rearward, pull the headrest all the way forward, then release.

### Forward adjustment

Pull headrest gently forward to allow adjustment to 3 different positions.

## FRONT SEAT ADJUSTMENT (Power) (if equipped)

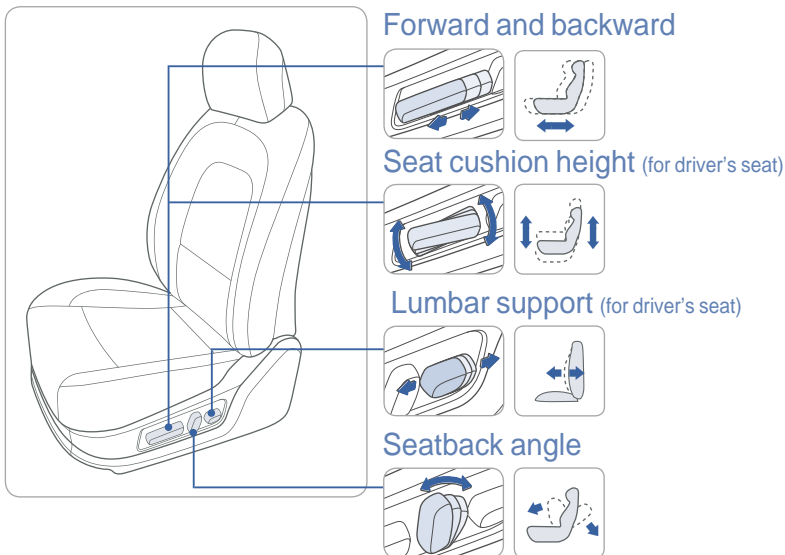

## REAR SEAT FOLDING

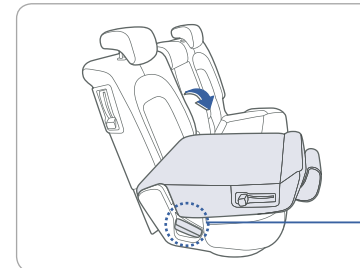

### 2nd row seat

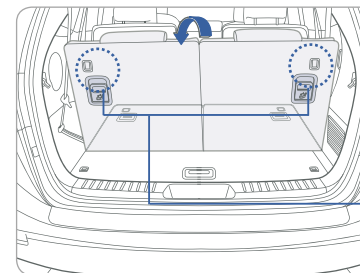
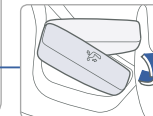

### 3rd row seat



## BASIC SAFETY PRECAUTIONS

Whenever operating the vehicle, make sure that you and your occupants are properly wearing your seat belts. Small children should always ride in the rear seat in the appropriate child restraint system (see the Owner's Manual for child safety details). Never place children under 13 years old in the front seats to avoid injury that may result from air bag deployment. Always refer to the Owner's Manual for complete safety precaution information.

### NOTE

If the driver's seat belt is not fastened when the ignition key is turned to the ON or START position, the seat belt reminder light will blink and the warning chime will sound for several seconds to remind the driver to fasten the driver's seat belt.

## TILT AND TELESCOPIC STEERING WHEEL

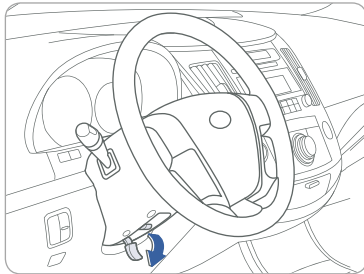

Tilt

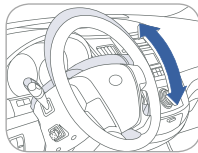

Telescopic

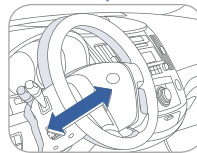

### NOTE

Do not adjust while driving.

### Manual (if equipped)

1. Pull down the lever.
2. Set the angle and distance.
3. Pull up the lever.

### Power (if equipped)

Set the angle and distance with the knob ①.

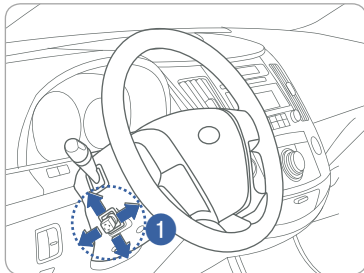

## SEAT BELT ADJUSTMENT (Front seat)

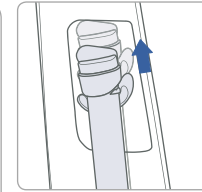
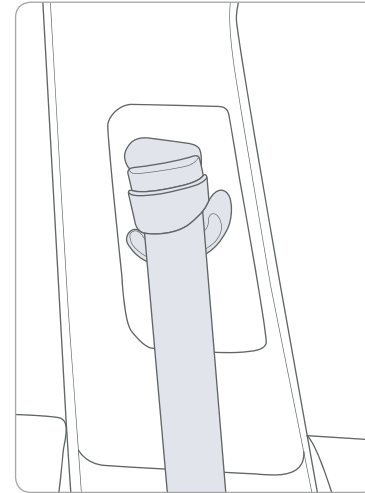

Pull up to raise.

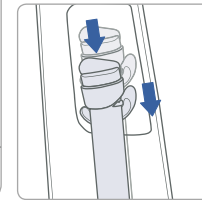

Press button and push down to lower.

## OCCUPANT CLASSIFICATION SYSTEM

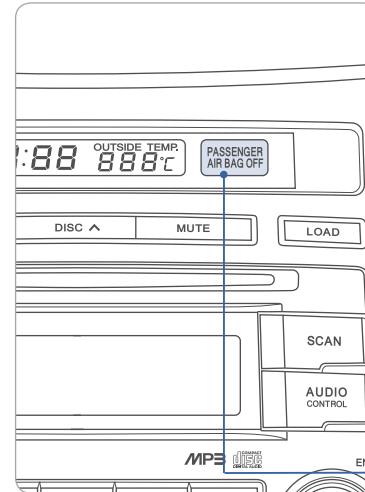

### Passenger Air Bag Off indicator light

The Occupant Classification System will disable the right front passenger's air bag under certain conditions (light on).

The light will not illuminate when the passenger's air bag is enabled.

Refer to the Owner's Manual for a complete description of this system.

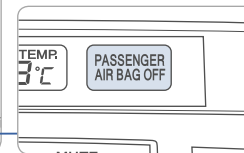

## INSIDE REARVIEW MIRROR

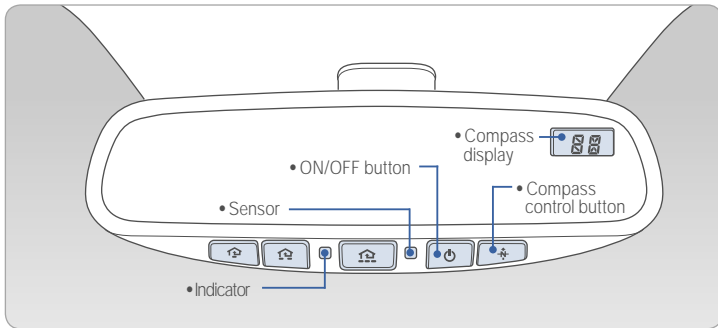

### Auto dimming mirror (if equipped)

- The mirror defaults to the ON position whenever the ignition switch is turned on.
- Press the ON/OFF button to turn the automatic dimming function off. The mirror indicator light will turn off.

### HomeLink® Wireless Control System (if equipped)

HomeLink® Wireless Control System can conveniently replace up to three handheld radio-frequency transmitters, such as garage doors, estate gates, and home lighting. Controls for HomeLink® are located in the lower portion of the inside rearview mirror.

Refer to your Owner's Manual for detailed instructions. Additional HomeLink® information can be found at [www.homelink.com](http://www.homelink.com) or by calling 1-800-355-3515.

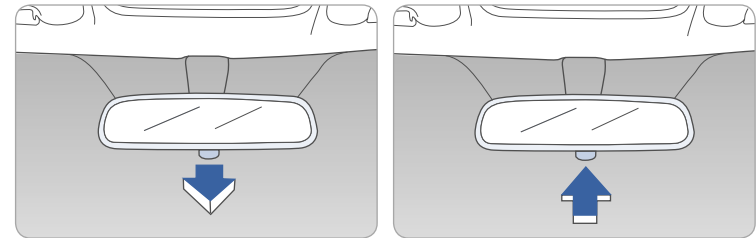

### Day/night rearview mirror

Pull the day/night lever toward you to reduce glare from the head lights of vehicles behind you during night driving.

## OUTSIDE REARVIEW MIRROR

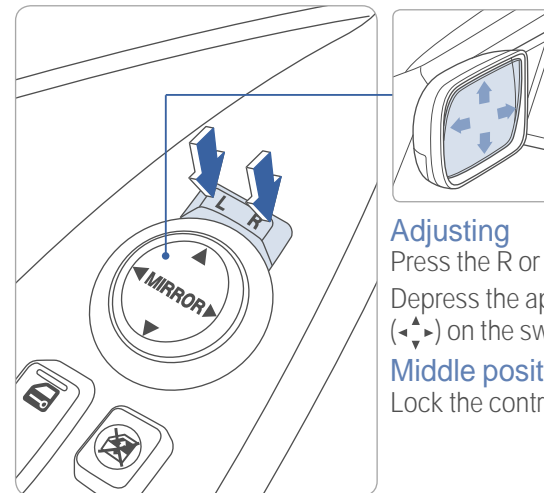

### Adjusting

Press the R or L button.

Depress the appropriate direction (↕) on the switch.

### Middle position

Lock the control.

## CENTRAL DOOR LOCK SWITCH

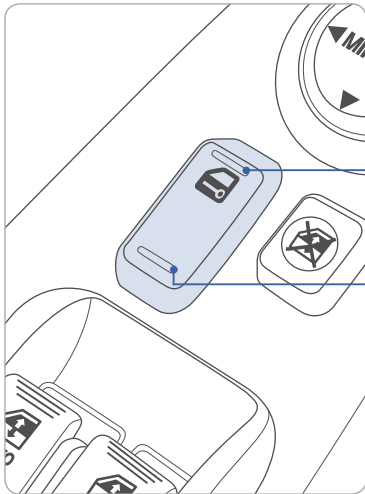

All doors will lock.

All doors will unlock.

## REMOTE KEYLESS ENTRY

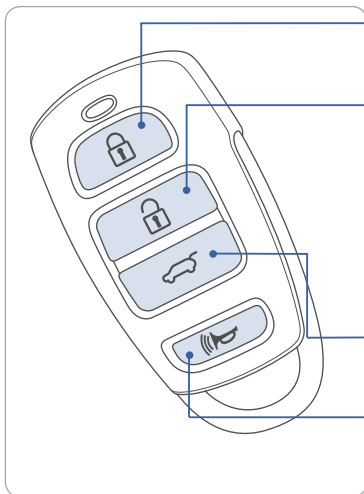

**Lock** (🔒)

Press the button.

**Unlock** (🔓)

Press the button.

Once - Unlock driver's door.

Twice - Unlock all doors.

**Tailgate unlock** (🚪)

Press and hold.

**Panic** (📢)

Press and hold.

Press any button to turn off panic.

## PROXIMITY KEY (if equipped)

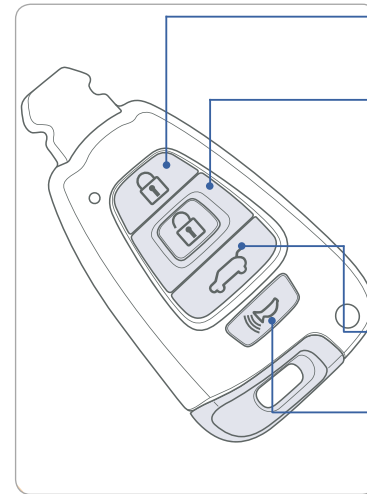

**Lock** (🔒)

Press the button.

**Unlock** (🔓)

Press the button.

Once - Unlock driver's door.

Twice - Unlock all doors.

**Power Tailgate** (🚪)

Press and hold to open or close.

**Panic** (📢)

Press and hold.

Press any button to turn off panic.

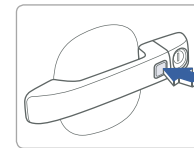

**Lock/Unlock**

Press the door handle button with the proximity key in range.

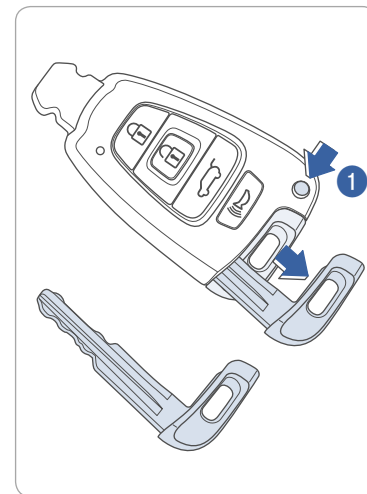

**Remove mechanical key**

Press and hold the release **1** button and remove the key.

**Reinstall mechanical key**

Put the key into the hole and push it until a click sound is heard.

Mechanical key may lock/unlock glove box and driver's door.

## CHILD-PROTECTOR REAR DOOR LOCK

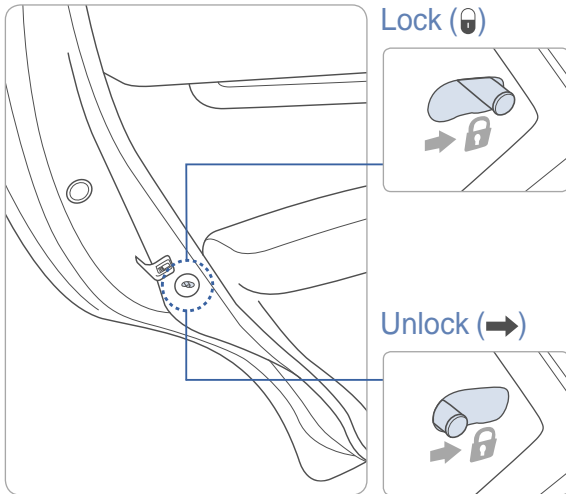

Lock (🔒)

Unlock (➡)

## POWER WINDOW

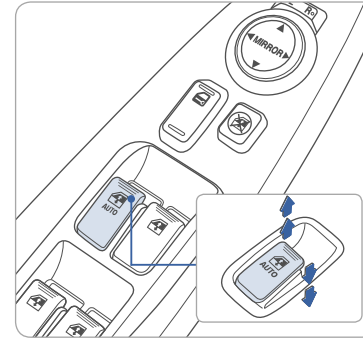

### Open

Press down the window switch.

### Close

Pull up the window switch.

### Auto down and up (driver's side only)

Press fully down or up once to open or close window.

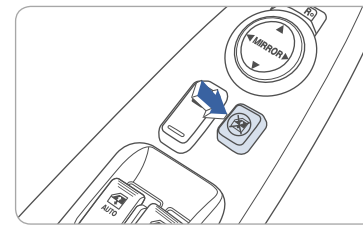

### Power Window Lock Switch

The driver can disable the power window switches on the passenger doors.

### Lock

Press the switch. (pressed in)

### Unlock

Press the switch again. (pressed out)

## HOOD RELEASE

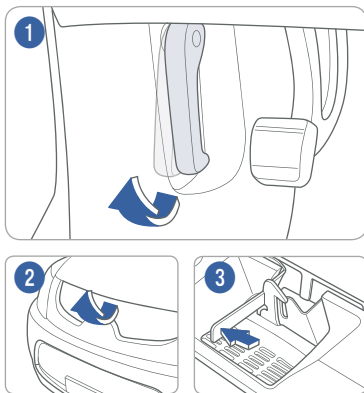

### Opening the hood

- 1 Pull the release lever to unlatch the hood.
- 2 Raise the hood slightly.
- 3 Pull the secondary latch inside of the hood center and lift the hood.

## FUEL FILLER LID

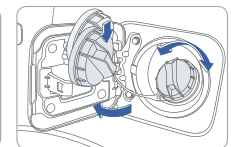
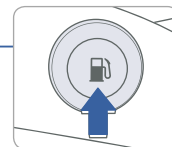
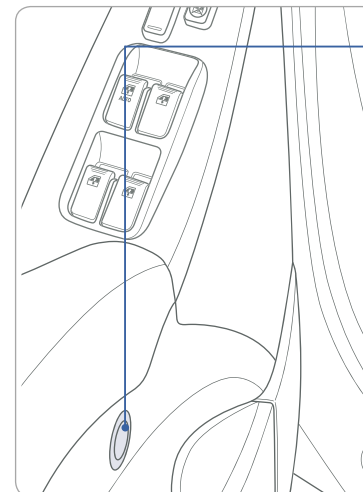

### NOTE

After adding fuel, always reinstall the fuel cap onto the filler neck by rotating it clockwise until it clicks one time.

Failure to do this may result in the Check Engine light illuminating.

## HEAD LIGHTS AND FOG LIGHTS (if equipped)

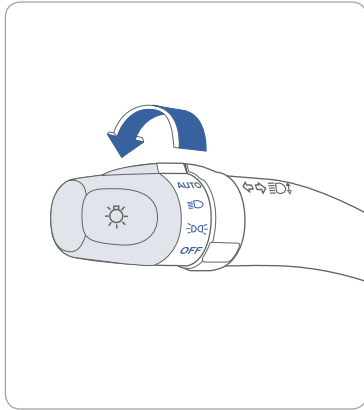

- ▶ | OFF OFF position
- ▶ | Parking light position
- ▶ | Head light position
- ▶ | **AUTO** Auto light position

\*if equipped

### Escort function (if equipped)

Head lights may stay on for 30 seconds after exiting and locking vehicle. Press remote lock button twice to turn head lights off. See Owner's Manual for more detail.

### Turn signals and lane change signals

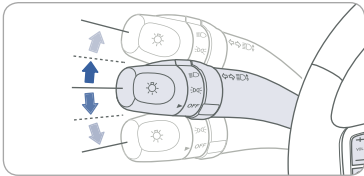

### Flashing head lights

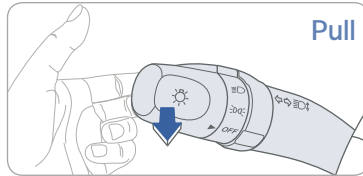

Pull

### High beam

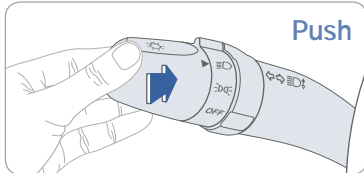

Push

### Fog light (if equipped)

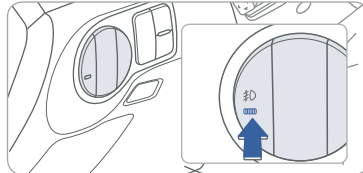

## WIPER AND WASHER

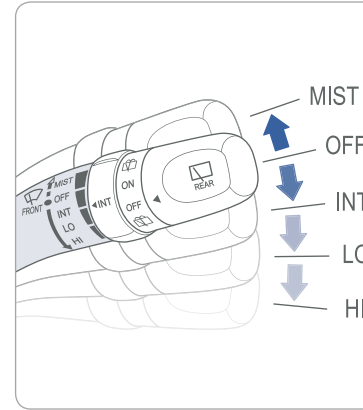

- MIST - Single wipe
- OFF - Off
- INT - Intermittent wipe
- AUTO - AUTO control wipe (if equipped)  
The rain sensor senses the amount of rainfall and controls the wiping cycle.
- LO - Normal wiper speed
- HI - Fast wiper speed

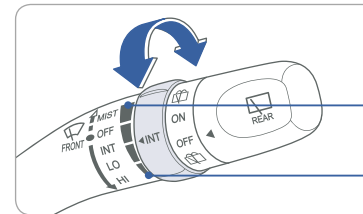

### Intermittent or AUTO control wipe time adjustment

Fast wiper speed

Slow wiper speed

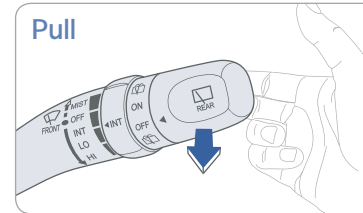

Pull

### Front washer with brief wipes

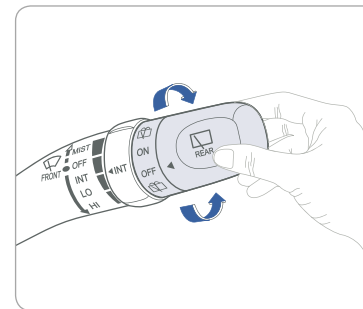

### Rear wiper/washer control (if equipped)

- Spraying washer fluid
- ON - Intermittent wipe after some normal wipe
- OFF - Off
- Wash with brief wipes

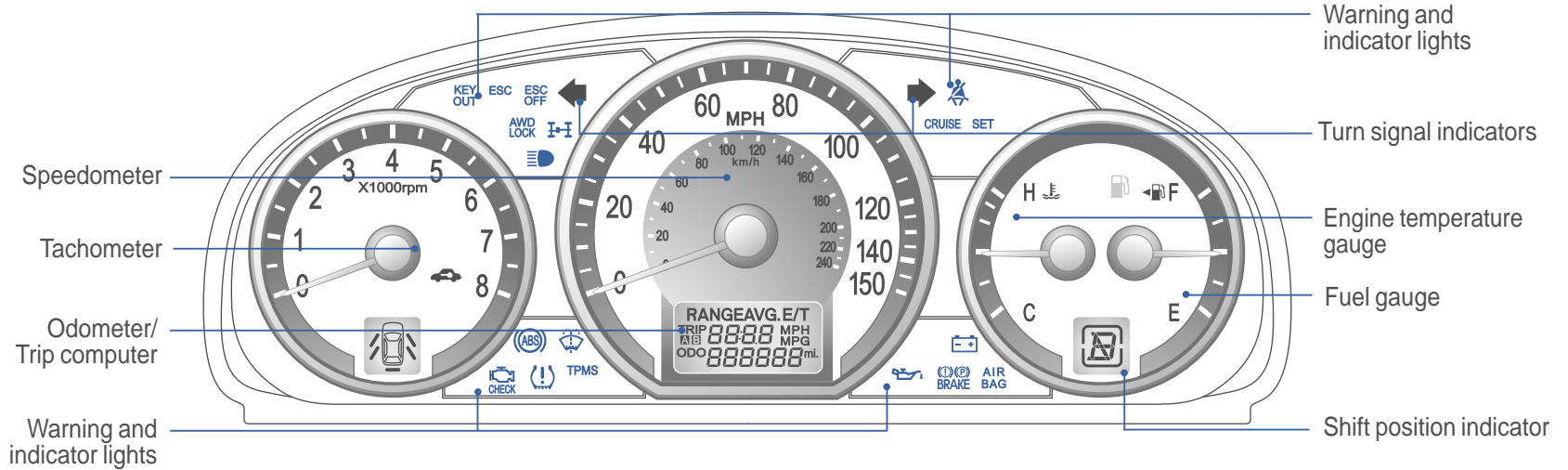

### WARNINGS AND INDICATORS

<b>AIR BAG</b> Air bag warning light	<b>BRAKE</b> Parking brake & Brake fluid warning light	<b>ABS</b> ABS warning light
Seat belt warning light	Low tire pressure indicator	<b>TPMS</b> TPMS (Tire Pressure Monitoring System) malfunction indicator
High beam indicator	Engine oil pressure warning light	Charging system warning light
Immobilizer indicator*	Door and tailgate open warning light	Turn signal indicator
<b>KEY OUT</b> KEY OUT indicator*	Shift position indicator	Low washer fluid level warning light*
<b>ESC OFF</b> ESC (Electronic Stability Control) OFF indicator	<b>ESC</b> ESC (Electronic Stability Control) indicator	Low fuel level warning light
<b>SET</b> Cruise SET indicator	<b>CRUISE</b> Cruise indicator	Malfunction indicator
<b>AWD LOCK</b> AWD LOCK indicator*	<b>I-I</b> AWD system warning light*	

\*if equipped

### INSTRUMENT PANEL ILLUMINATION

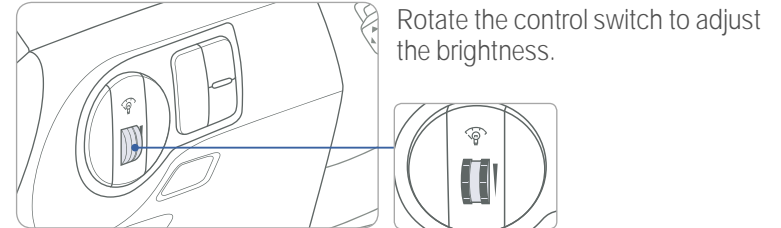

### TRIP COMPUTER (if equipped)

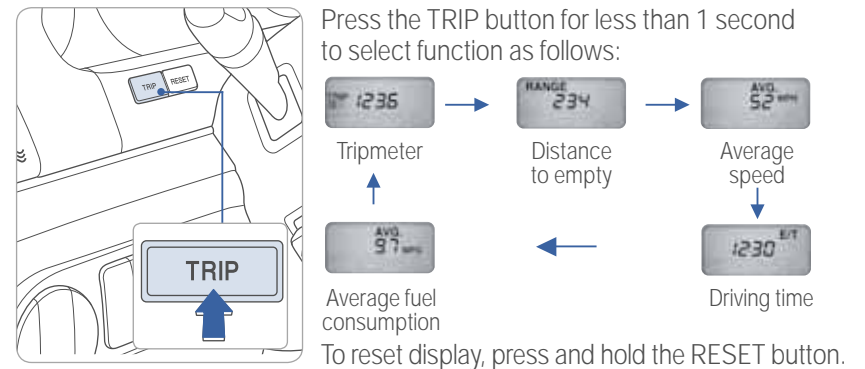

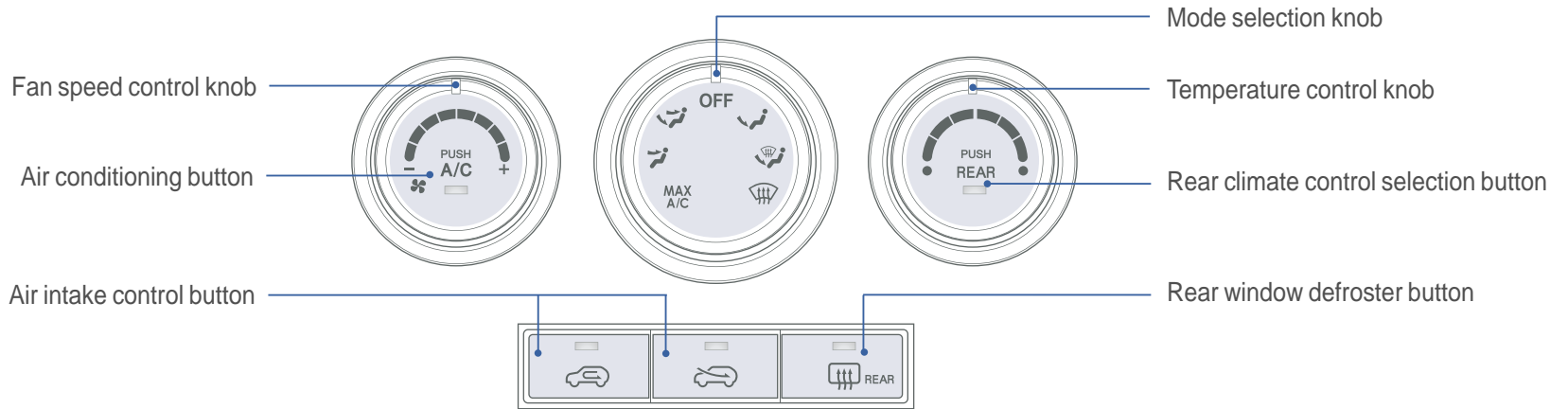

### DEFROSTING / DEFOGGING



1. Set the mode to the position.



2. Set the temperature control to the warmest setting.



3. Set the fan speed to the highest setting.

### NOTE

Setting the temperature control toward warm helps the defrosting process.

### REAR WINDOW DEFROSTER

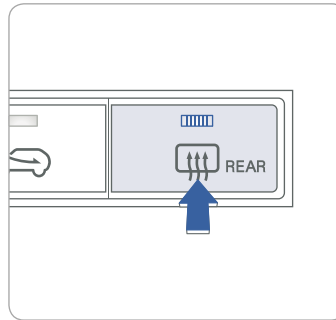

Press to activate/deactivate the rear defroster.

### MODE SELECTION

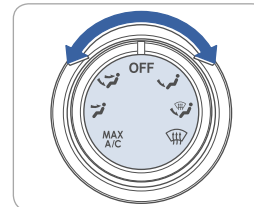

Changing the direction of the air flow as follows:



MAX A/C Level



Face Level



Bi-Level



Off Mode

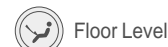

Floor Level



Floor/Defrost Level



Defrost Level

### AIR INTAKE CONTROL

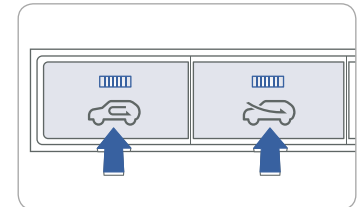

Recirculated air position



Outside (fresh) air position

**AUTOMATIC CLIMATE CONTROL (if equipped)**

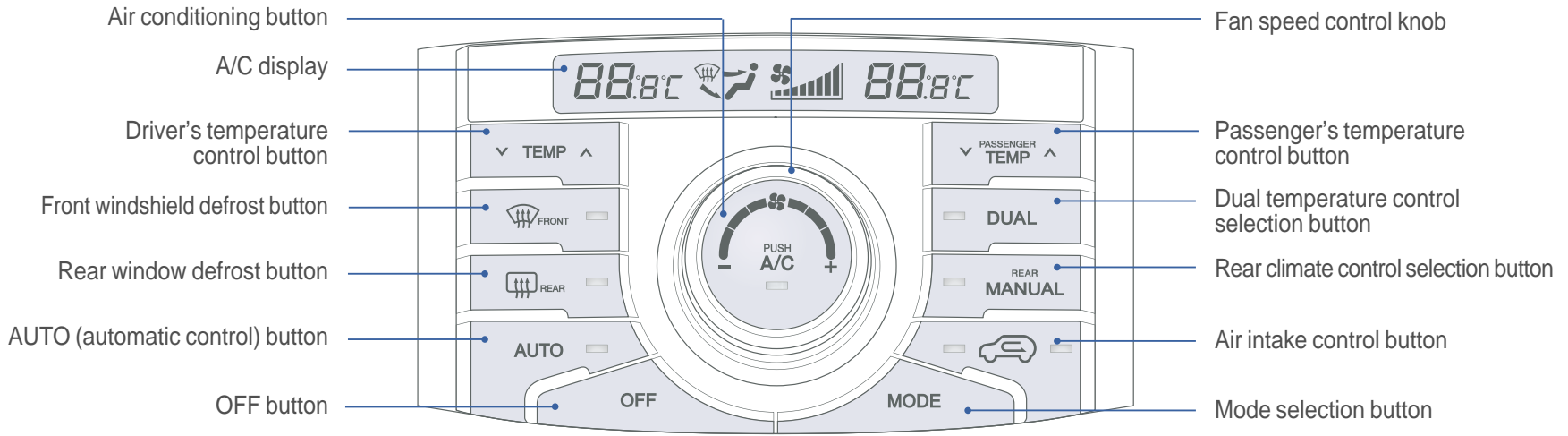

**DEFROSTING / DEFOGGING**

1. Press the front windshield defrost control.
2. Set the temperature control to the warmest setting.
3. Set the fan speed to the highest setting.

**REAR WINDOW DEFROSTER**

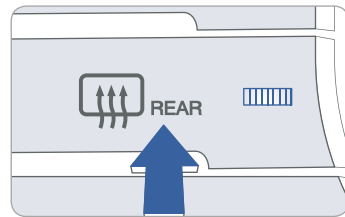

Press to activate / deactivate the rear defroster.

**AIR INTAKE CONTROL**

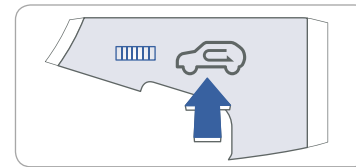

- Recirculated air position
- Outside (fresh) air position

**DUAL BUTTON**

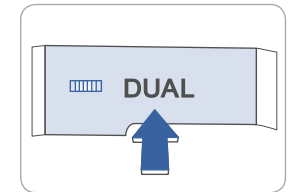

Press the DUAL button to operate the driver's and passenger's side temperature individually.

**NOTE**

Setting the temperature control toward warm helps the defrosting process.

**SYSTEM OFF MODE**

Pressing the OFF button will place the system in the off mode.

- Front blower will turn off.
- Outside (fresh) air position selected.
- Vented air at last set temperature.

**MODE SELECTION**

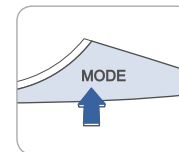

Changing the direction of the air flow as follows:



## AUDIO (if equipped)

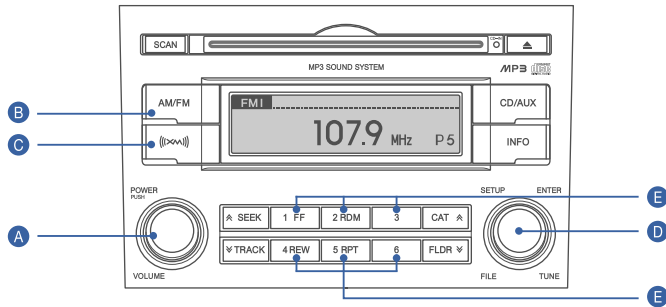

Press **POWER** button **A** to turn radio on.

### • TUNING / LISTENING TO CHANNELS

1. Press AM/FM **B** or XM<sup>®</sup> **C**.
2. Rotate Audio Control knob **D** to desired channel.

#### NOTE

A clear view of the southern sky is recommended to ensure XM<sup>®</sup> radio reception.

### • SETTING PRESET MEMORY BUTTONS (FM/AM/XM<sup>®</sup>)

Press and hold any preset button (1-6) **E** until audible beep is heard to store current channel.

### • ADJUSTING THE SOUND CONTROL

1. Press TUNE knob **D**.
2. Select "Bass, Middle, Treble, Fader, Balance" by pressing on TUNE knob **D**. Rotate TUNE knob **D** to adjust.
3. Press TUNE knob **D** when done.

## STEERING WHEEL AUDIO CONTROL (if equipped)

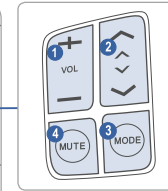
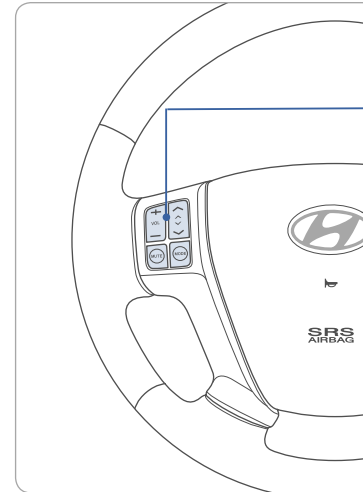

- 1 VOLUME**  
Raises or lowers speaker volume.
- 2 SEEK/PRESET**  
Change station.
- 3 MODE**  
Change the audio source.
- 4 MUTE**  
Mute the sound.

Please refer to your Owner's Manual for more detailed information on how to use your audio system. Complimentary XM<sup>®</sup> subscription ends three months following the vehicle date of sale. Please contact XM<sup>®</sup> Radio at 1-800-XM-RADIO (1-800-967-2346) to renew your XM<sup>®</sup> subscription.

## AUX, USB AND iPod PORT (if equipped)

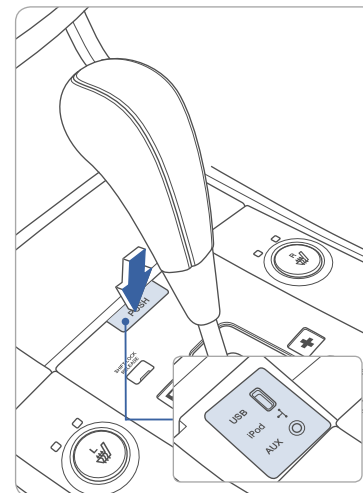

Use the jack to connect an external audio device and listen to it through the audio system in your vehicle.

#### NOTE

To operate your iPod<sup>®</sup> through the vehicle's audio system, a Hyundai adapter cable is required. This cable can only be purchased at your local Hyundai dealer.

iPod<sup>®</sup> is a trademark of Apple Inc.

## SEAT WARMER (if equipped)

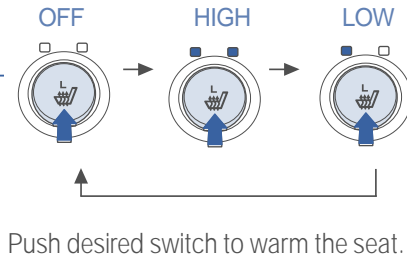
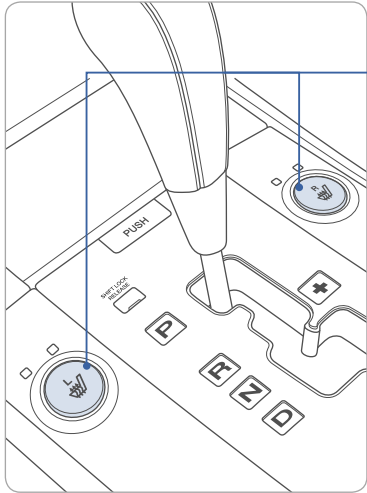

## CLOCK ADJUSTMENT

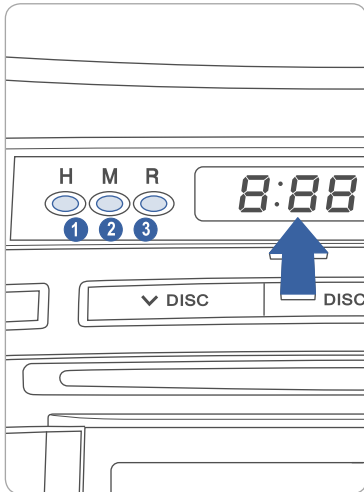

**Hour 1**  
Pressing the H button will advance the time displayed by one hour.

**Minute 2**  
Pressing the M button will advance the time displayed by one minute.

**Reset 3**  
Pressing the R button will make the clock be set on the hour. Press and hold Reset button to toggle between 12 or 24 hours.

## SUNROOF

### Sliding the sunroof

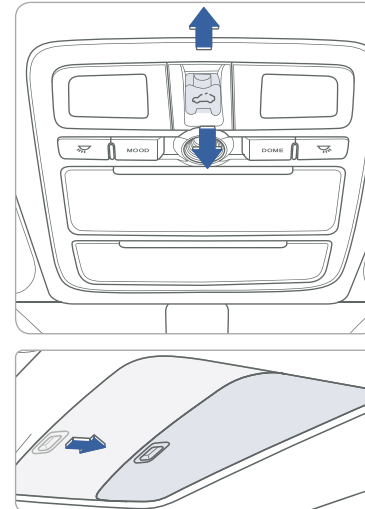

#### Open

Press switch rearward.  
Press switch rearward past the detent to automatically open completely.

#### Close

Press switch forward.  
Press switch forward past the detent to automatically close completely.

### Tilting the sunroof

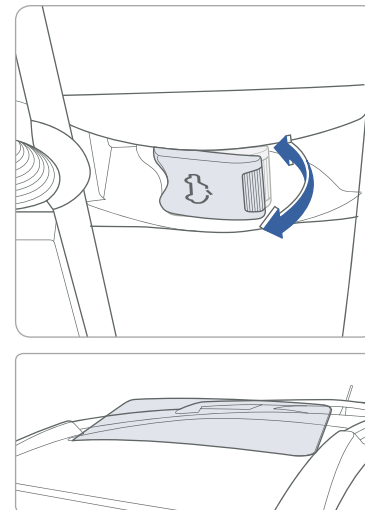

#### Tilt

Push or pull switch up or down.

#### NOTE

Do not leave the sunshade closed while the sun roof is being opened.

## INTERIOR LIGHTS

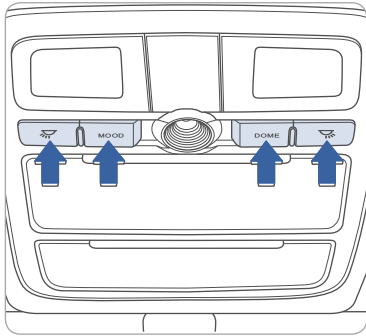

Push the switch to turn the map lamp on or off.

### MOOD

Push the switch to turn the mood lamp on or off.

### DOME

Push the switch to turn the rear room lamp on or off.

## TIRE PRESSURE MONITORING SYSTEM (TPMS)

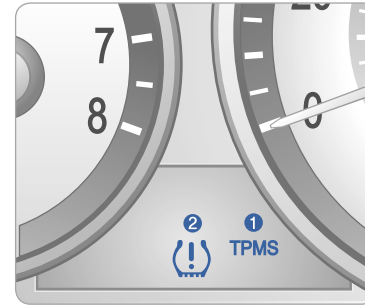

TPMS Malfunction Indicator **1**  
Low Tire Pressure Indicator **2**

### Low Tire Pressure Indicator

Illuminates if one or more of your tires is significantly under-inflated.

### TPMS Malfunction Indicator

Illuminates when there is malfunction with the TPMS system. Inspect all tires and adjust tire pressure to specification. If the lamp remains illuminated, have the system checked by an authorized Hyundai dealer as soon as possible.

## CRUISE CONTROL SYSTEM

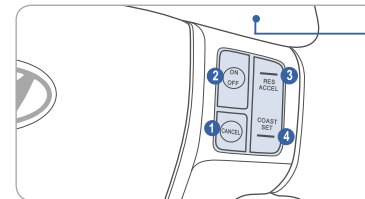

**CRUISE** Cruise indicator

**SET** Cruise set indicator

### To set a cruising speed

1. Press ON/OFF button **2** and the CRUISE indicator will illuminate in the instrument cluster.  
Accelerate to desired cruising speed (above 25 mph).
2. Press COAST/SET button **4** and remove your foot from the accelerator pedal.

### To accelerate or decelerate

Press RES/ACCEL button **3** up to increase set cruising speed.  
Press COAST/SET button **4** down to decrease set cruising speed.

### To cancel cruising speed

Press CANCEL button **1**, or depress brake pedal, or press ON/OFF button **2**.

## TRANSMISSION

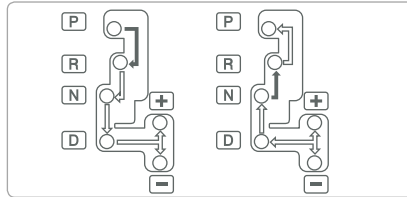
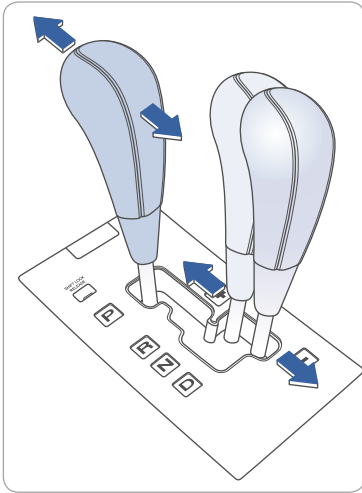

Depress the brake pedal when shifting.



The shift lever can be shifted freely.

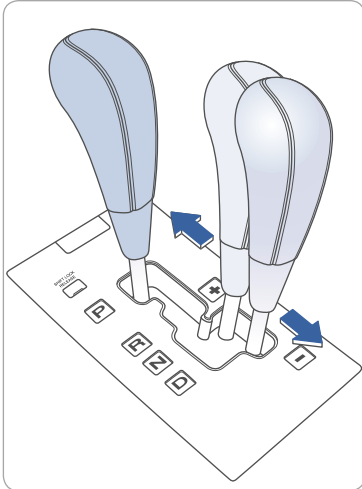

### Sport mode

Move the shift lever from D to the right gate to select.

Move the shift lever forward (+) to upshift or rearward (-) to downshift.

## AWD LOCK (if equipped)

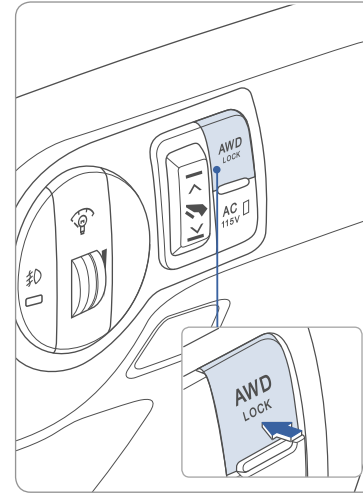

During off-road or inclement weather conditions, press the AWD LOCK switch to drive in full-time AWD.

## ELECTRONIC STABILITY CONTROL (ESC)

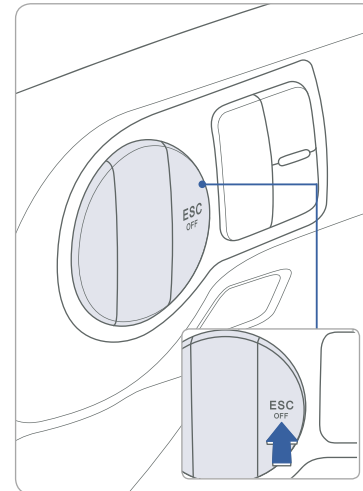

The ESC system is an electronic system designed to help the driver maintain vehicle control under adverse conditions.

- To turn ESC off, press the ESC OFF button.
- To turn ESC on, press it again.
- System automatically selects the ON position when the engine is started.



## VERACRUZ CUSTOMER DELIVERY CHECK LIST (continued)

### Tire Pressure Monitoring System (TPMS) - Page 25



#### Low Tire Pressure Indicator

Illuminates if one or more of your tires is significantly under-inflated.

#### TPMS Malfunction Indicator

Illuminates when there is malfunction with the TPMS system. Have the system checked by an authorized Hyundai dealer as soon as possible.

**TPMS**

### Windshield wiper / washer - Page 13

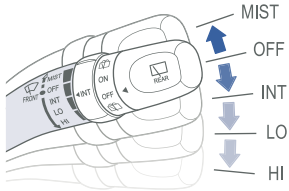

- To activate wipers, move the switch down to one of the three positions (INT, LO, HI).
- To adjust INT speed, rotate dial.
- To spray washer fluid, pull lever toward you.
- Push lever up for a single wiper pass.

### Unlocking vehicle - Page 8

Demonstrate dual state unlock with key and remote keyless entry.

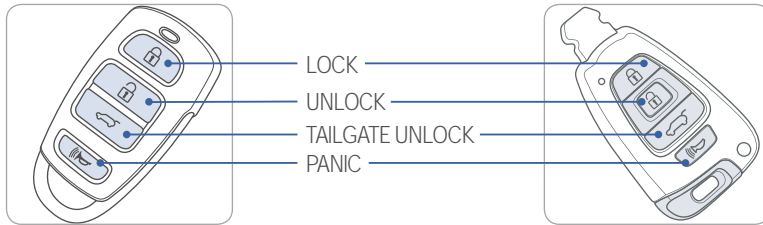

### DURING DELIVERY

- DEMONSTRATE AUDIO SYSTEM OPERATION INCLUDING PRESETS (OPTIONAL - iPod® CABLE AVAILABLE)
- CONSIDER OWNER'S PREVIOUS VEHICLE TO EXPLAIN WIPER/ HEADLIGHT FUNCTIONS
- DEMONSTRATE HOW TO SET THE CLOCK
- EXPLAIN AND REVIEW FIRST SERVICE PROCEDURE AND AMERICA'S BEST WARRANTY—PROVIDE SERVICE REPRESENTATIVE BUSINESS CARD
- ASK IF CUSTOMER HAS ANY QUESTIONS

Sales Consultant	Date	Sales Manager	Date
Customer			Date
@			
Email			

## VERACRUZ CUSTOMER DELIVERY CHECK LIST

HYUNDAI OWNER	DEALERSHIP NAME
SALES CONSULTANT	DATE
VIN	PREVIOUS VEHICLE

### BEFORE DELIVERY

- CONFIRM "GOOD BATTERY" AND STAPLE TEST TICKET HERE  
 β MIDTRONICS TEST
- VERIFY ALL TIRE PRESSURES ARE 30PSI  
 LF  LR  RF  RR
- VERIFY ALL REMOTE FUNCTIONS: LOCK / UNLOCK / ALARM
- VERIFY VEHICLE IS CLEAN, IN GOOD CONDITION, FREE OF CHIPS AND SCRATCHES
- ENSURE FLOORMATS ARE SNAPPED INTO PLACE (if applicable)

### WALK THE CUSTOMER THROUGH EACH OF THE FOLLOWING KEY DELIVERY FEATURES

#### Height adjustment - Page 3

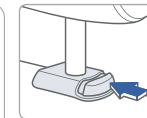
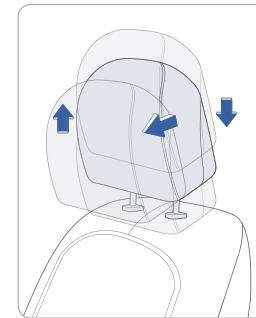

#### Height adjustment

Lock knob  
 Pull up to raise.  
 Press lock knob to lower.

#### Backward adjustment

To adjust the headrest rearward, pull the headrest all the way forward, then release.

#### Forward adjustment

Pull headrest gently forward to allow adjustment to 3 different positions.

### Manual / Automatic climate control - Pages 16 ~19

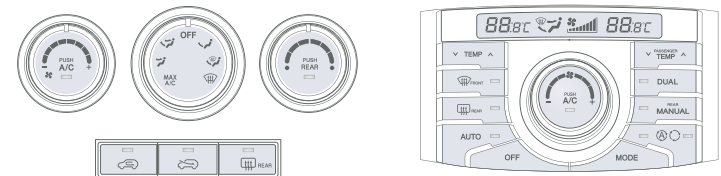

β To speed up front windshield defogging, increase temperature and fan speed and then select defrost button.